

HD 900 x

12/2015

RL Motor Factors Ltd
 Chapel Street
 Charleville, Co Cork
 063-89788
www.rlmotorfactors.ie



Filter type	Hydraulics
GTIN code	4011558044435
Delivery status	available

Dimensions (mm)

A	B	H
90	42	240



Representative image

Cross reference

CLAAS
00 0598 078 0

Application

		kW	HP	⌚
OFF-HIGHWAY APPLICATIONS				
Agricultural machinery				
CLAAS Xerion (Traktoren / Tractors) 3300 Gearbox transmission intake filter.	CAT-C9	224	305	2004->
CLAAS Xerion (Traktoren / Tractors) 3300 Gearbox transmission intake filter.	CAT-C9	224	305	2004->
CLAAS Xerion (Traktoren / Tractors) 3800 Gearbox transmission intake filter.	CAT-C9	253	344	2007->

49 302 53 911

12/2015



Filter type	Compressed air-oil separation
GTIN code	4011558058289
Delivery status	available

Dimensions (mm)

A	C	H
274	220	230

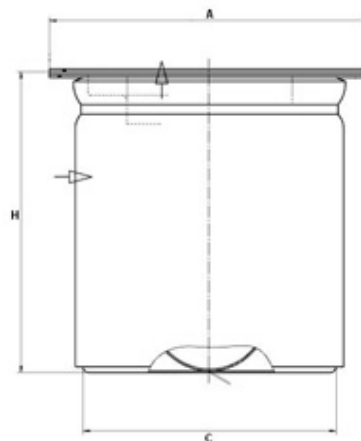

Representative image

C 26 024

12/2015

Available
now!

MANN FILTER

Filter type	Air Filter
GTIN code	4011558068660
Delivery status	available

Dimensions (mm)

A	B	H
260	135	500

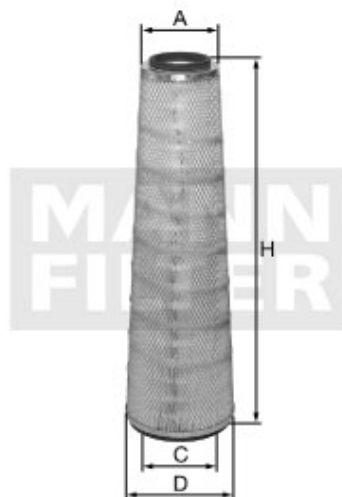

Representative image

Cross reference



DAF
1931681
1931685
185 4407

Competitor no.

BALDWIN
RS5754
DONALDSON
P951919
HIFI-FILTER
SA 16825

MECAFILTER
FA 3578
SCHUPP / SF FILTER
SL 81928

Application



			kW	HP	
	TRUCKS + BUSES				
DAF TRUCKS New XF (XF106) 400	MX11 (Euro 6)		291	400	09/13->
DAF TRUCKS New XF (XF106) 410	MX13 (Euro 6)		303	412	04/13->
DAF TRUCKS New XF (XF106) 440	MX11 (Euro 6)		320	440	09/13->
DAF TRUCKS New XF (XF106) 460	MX13 (Euro 6)		340	462	04/13->
DAF TRUCKS New XF (XF106) 510	MX13 (Euro 6)		375	510	04/13->
DAF TRUCKS XF105 105.410	MX 300 S (Euro 4/5/EEV)		300	408	01/06->
07/11->					
DAF TRUCKS XF105 105.460	MX 340 S (Euro 4/5/EEV)		340	462	01/06->
07/11->					
DAF TRUCKS XF105 105.510	MX 375 S (Euro 4/5/EEV)		375	510	01/06->

C 26 024

12/2015



Application

		kW	HP	
07/11->				
DAF TRUCKS XF105 105.560	MX 410 S (Euro 4/5/EEV)	410	560	04/06->
07/11->				

C 34 120

12/2015

Available
now!

**MANN
FILTER**

Filter type	Air Filter
GTIN code	4011558068578
Delivery status	available

Dimensions (mm)

A	B	H
340	115	75

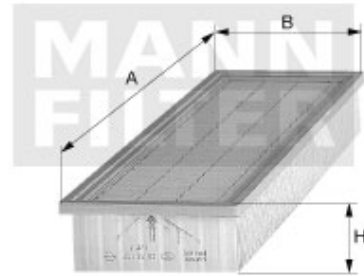

Representative image



Cross reference

BMW
13 71 8 570 043

Competitor no.

COOPERSFIAAM	PURFLUX
PA7829	A1739
FRAM	TECNOCAR
CA11914	A2555
HENGST	
E1171L	
MECAFILTER	
ELP 9452	

Application

		kW	HP	
 CARS + TRANSPORTERS				
BMW 5 (F10/F11/F18) 518 d	B47 D20A	110	150	07/14->
BMW 5 (F10/F11/F18) 520 d	B47 D20	140	190	07/14->
BMW X3 (F25) 18 d	B47 D20A	110	150	04/14->
BMW X3 (F25) 20 dX	B47 D20	140	190	04/14->
BMW X4 (F26) 20 dX	B47 D20	140	190	04/14->
BMW X5 (F15, F85) 25d	B47D20A	170	231	07/15->

CUK 22 011

12/2015



Filter type	Cabin Filter
GTIN code	4011558066659
Delivery status	available
Product Details	Activated charcoal filter



Dimensions (mm)

A	B	H
216	200	35

Cross reference

RENAULT
27 27 796 83R
27 27 705 67R

Competitor no.

BOSCH
1 987 435 031
COOPERSFIAAM
PCK8374
CORTECO
80004639
CC1465
FRAM
PCK8374
CFA11706
HENGST
E3914LC



MAHLE (KNECHT/MAHLE)
LAK923
MECAFILTER
EKR 7295
S 4227 CA
PURFLUX
AHC405
TECNOCAR
EC696
UFI
54.227.00

Application

		kW	HP	
CARS + TRANSPORTERS				
DACIA (RENAULT GROUP) Logan II 0.9 TCe	H4B	66	90	05/13->
System VALEO.				
DACIA (RENAULT GROUP) Logan II 1.2	D4F	54	73	05/15->
System VALEO.				
DACIA (RENAULT GROUP) Logan II 1.2 16V	D4F732	55	75	05/13->
System VALEO.				
DACIA (RENAULT GROUP) Logan II 1.2 16V LPG	D4F734	53	72	05/13->
System VALEO.				
DACIA (RENAULT GROUP) Logan II 1.5 dCi	K9K	55	75	05/13->
System VALEO.				



Application



		kW	HP	
DACIA (RENAULT GROUP) Logan II 1.5 dCi 90	K9K	66	90	05/13->
System VALEO.				
DACIA (RENAULT GROUP) Logan II 1.6	K7M	61	83	05/13->
System VALEO.				
DACIA (RENAULT GROUP) Logan II 1.6	K7M	77	105	01/13->
System VALEO.				
DACIA (RENAULT GROUP) Logan II 1.6	K7M	75	102	04/15->
System VALEO.				
DACIA (RENAULT GROUP) Sandero II 0.9 TCe	H4B	66	90	01/13->
System VALEO.				
DACIA (RENAULT GROUP) Sandero II 1.2	D4F	54	73	05/15->
System VALEO.				
DACIA (RENAULT GROUP) Sandero II 1.2 16V	D4F	55	75	01/13->
System VALEO.				
DACIA (RENAULT GROUP) Sandero II 1.2 16V LPG	D4F	53	72	01/13->
System VALEO.				
DACIA (RENAULT GROUP) Sandero II 1.5 dCi	K9K	55	75	01/13->
System VALEO.				
DACIA (RENAULT GROUP) Sandero II 1.5 dCi 90	K9K	66	90	01/13->
System VALEO.				
DACIA (RENAULT GROUP) Sandero II 1.6	K7M	61	83	01/13->
System VALEO.				
DACIA (RENAULT GROUP) Sandero II 1.6	K7M	75	102	04/15->
System VALEO.				
DACIA (RENAULT GROUP) Sandero II 1.6 16V	K4M 690	77	105	01/13->
System VALEO.				
RENAULT Captur 0.9 TCe 90	H4B400	66	90	05/13->
RENAULT Captur 1.2 TCe 120	H4F	88	120	05/13->
RENAULT Captur 1.5 dCi 110	K9K	81	110	02/15->
RENAULT Captur 1.5 dCi 90	K9K608	66	90	05/13->
RENAULT Clio IV 0.9 TCe	H4B400	66	90	11/12->
System VALEO.				
RENAULT Clio IV 1.2 16V	D4F740/744	54	74	11/12->
System VALEO.				
RENAULT Clio IV 1.2 TCe 120	H4F	88	120	11/12->
System VALEO.				
RENAULT Clio IV 1.5 dCi	K9K608	66	90	11/12->
System VALEO.				
RENAULT Clio IV 1.5 dCi	K9K612	55	75	11/12->
System VALEO.				

CUK 22 011

12/2015



Application

		kW	HP	
RENAULT Clio IV 1.6 RS	M5M	147	200	03/13->
System VALEO.				
RENAULT Clio IV 1.6 RS Trophy	M5M	162	220	03/15->
System VALEO.				
RENAULT Logan II 0.9 TCe	H4B	66	90	05/13->
System VALEO.				
RENAULT Logan II 1.2 16V	D4F732	55	75	05/13->
System VALEO.				
RENAULT Logan II 1.2 16V LPG	D4F734	53	72	05/13->
System VALEO.				
RENAULT Logan II 1.5 dCi	K9K	55	75	05/13->
System VALEO.				
RENAULT Logan II 1.5 dCi 90	K9K	66	90	05/13->
System VALEO.				
RENAULT Logan II 1.6	K7M	61	83	05/13->
System VALEO.				
RENAULT Logan II 1.6	K7M	77	105	01/13->
System VALEO.				
RENAULT Logan II 1.6	K7M	75	102	04/15->
System VALEO.				
RENAULT Sandero II 0.9 TCe	H4B	66	90	01/13->
System VALEO.				
RENAULT Sandero II 1.2	D4F	54	73	05/15->
System VALEO.				
RENAULT Sandero II 1.2 16V	D4F	55	75	01/13->
System VALEO.				
RENAULT Sandero II 1.2 16V LPG	D4F	53	72	01/13->
System VALEO.				
RENAULT Sandero II 1.5 dCi	K9K	55	75	01/13->
System VALEO.				
RENAULT Sandero II 1.5 dCi 90	K9K	66	90	01/13->
System VALEO.				
RENAULT Sandero II 1.6	K7M	61	83	01/13->
System VALEO.				
RENAULT Sandero II 1.6	K7M	75	102	04/15->
System VALEO.				
RENAULT Sandero II 1.6 16V	K4M 690	77	105	01/13->
System VALEO.				

FP 22 013

12/2015





no image available

Filter type	Cabin Filter
GTIN code	4011558065300
Delivery status	available
Product Details	FreciousPlus. Biofunctional cabin filter

Cross reference

FOMOCO
6C11-19G244-AAK
FORD
1748 479
1748 480
1745 604
1745 605
8C16 16N619 A2A

Application



			kW	HP	
CARS + TRANSPORTERS					
FORD Transit 2007 2.2 TDCi			63	85	07/06-11/11
Biofunctional cabin filter.					
FORD Transit 2007 2.2 TDCi			81	110	07/06-11/11
Biofunctional cabin filter.					
FORD Transit 2007 2.2 TDCi			96	130	07/06-11/11
Biofunctional cabin filter.					
FORD Transit 2007 2.2 TDCi			103	140	10/07->
Biofunctional cabin filter.					
FORD Transit 2007 2.2 TDCi			114	155	09/11->
Biofunctional cabin filter.					
FORD Transit 2007 2.2 TDCi	USRA / USRB		100	135	09/11->
Biofunctional cabin filter.					
FORD Transit 2007 2.2 TDCi, TDCi ECONetic			85	115	10/08-11/11
Biofunctional cabin filter.					
FORD Transit 2007 2.2 TDCi, TDCi ECONetic			74	100	09/11->
Biofunctional cabin filter.					
FORD Transit 2007 2.2 TDCi, TDCi ECONetic			92	125	09/11->
Biofunctional cabin filter.					
FORD Transit 2007 2.3 16V			107	145	07/06->
Biofunctional cabin filter.					
FORD Transit 2007 2.3 16V CNG			107	145	10/06->
Biofunctional cabin filter.					

FP 22 013

12/2015



Application

		kW	HP	
FORD Transit 2007 2.4 TDCi		74	100	07/06-11/11
Biofunctional cabin filter.				
FORD Transit 2007 2.4 TDCi		85	115	07/06-11/11
Biofunctional cabin filter.				
FORD Transit 2007 2.4 TDCi		103	140	07/06-11/11
Biofunctional cabin filter.				
FORD Transit 2007 3.2 TDCi	Duratorq DI 3.2	147	200	10/07-11/11
Biofunctional cabin filter.				

FP 29 005/1

12/2015



Filter type	Cabin Filter
GTIN code	4011558067014
Delivery status	available
Product Details	FreciousPlus. Biofunctional cabin filter

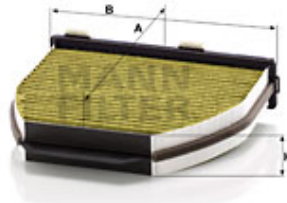

Dimensions (mm)

A	B	H
264	284	44

Cross reference



MERCEDES-BENZ (DAIMLER AG)
A 212 830 01 18
A 212 830 02 18
A 212 830 03 18
A 204 830 00 18
A 204 830 05 18
A 212 830 00 18
212 830 03 18
204 830 05 18
212 830 02 18
212 830 01 18
212 830 00 18
204 830 00 18

Application

		kW	HP	⌚
	CARS + TRANSPORTERS			
MERCEDES-BENZ AMG GT / GT S (C190) 4.0 GT	M 178.980	340	462	10/14->
Biofunctional cabin filter. right-hand drive.				
MERCEDES-BENZ AMG GT / GT S (C190) 4.0 GT S	M 178.980	375	510	10/14->
Biofunctional cabin filter. right-hand drive.				
MERCEDES-BENZ C-Klasse (W204/C204/S204) C 180 1.6 BlueEFFICIENCY	M 274.910	115	156	08/12->
Biofunctional cabin filter. right-hand drive.				
MERCEDES-BENZ C-Klasse (W204/C204/S204) C 180 1.8 CGI BlueEFFICIENCY	M 271.820	115	156	11/09->
Biofunctional cabin filter. right-hand drive.				
MERCEDES-BENZ C-Klasse (W204/C204/S204) C 180 CDI BlueEFFICIENCY	OM 651.913	88	120	03/11->
Biofunctional cabin filter. right-hand drive.				
MERCEDES-BENZ C-Klasse (W204/C204/S204) C 180 K BlueEFFICIENCY	M 271.910	115	156	04/08-12/09





Application

		kW	HP	
Biofunctional cabin filter. right-hand drive.				
MERCEDES-BENZ C-Klasse (W204/C204/S204) C 180 Kompressor	M 271.952	115	156	09/07-12/09
Biofunctional cabin filter. right-hand drive.				
MERCEDES-BENZ C-Klasse (W204/C204/S204) C 200 CDI	OM 646.811	100	136	08/07-11/09
Biofunctional cabin filter. right-hand drive.				
MERCEDES-BENZ C-Klasse (W204/C204/S204) C 200 CDI BlueEFFICIENCY	OM 646.812	100	136	04/08-11/09
Biofunctional cabin filter. right-hand drive.				
MERCEDES-BENZ C-Klasse (W204/C204/S204) C 200 CDI BlueEFFICIENCY	OM 651.913	100	136	12/09->
Biofunctional cabin filter. right-hand drive.				
MERCEDES-BENZ C-Klasse (W204/C204/S204) C 200 CGI BlueEFFICIENCY	M 271.820/860	135	184	09/09->
Biofunctional cabin filter. right-hand drive.				
MERCEDES-BENZ C-Klasse (W204/C204/S204) C 200 Kompressor	M 271.950, M 271.820/860	135	184	03/07-12/09
Biofunctional cabin filter. right-hand drive.				
MERCEDES-BENZ C-Klasse (W204/C204/S204) C 220 CDI	OM 646.811	125	170	03/07-10/08
Biofunctional cabin filter. right-hand drive.				
MERCEDES-BENZ C-Klasse (W204/C204/S204) C 220 CDI BlueEFFICIENCY	OM 651.911/912	125	170	11/08->
Biofunctional cabin filter. right-hand drive.				
MERCEDES-BENZ C-Klasse (W204/C204/S204) C 230	M 272.921	150	204	08/07-10/09
Biofunctional cabin filter. right-hand drive.				
MERCEDES-BENZ C-Klasse (W204/C204/S204) C 250 CDI 4MATIC	OM 651.912	150	204	05/10->
Biofunctional cabin filter. right-hand drive.				
MERCEDES-BENZ C-Klasse (W204/C204/S204) C 250 CDI BlueEFFICIENCY	OM 651.911	150	204	11/08->
Biofunctional cabin filter. right-hand drive.				
MERCEDES-BENZ C-Klasse (W204/C204/S204) C 250 CGI BlueEFFICIENCY	M 271.860	150	204	09/09->
Biofunctional cabin filter. right-hand drive.				
MERCEDES-BENZ C-Klasse (W204/C204/S204) C 280	M 272.947	170	231	03/07-07/09
Biofunctional cabin filter. right-hand drive.				
MERCEDES-BENZ C-Klasse (W204/C204/S204) C 300	M 272.947	170	231	07/09->
Biofunctional cabin filter. right-hand drive.				
MERCEDES-BENZ C-Klasse (W204/C204/S204) C 300 CDI BlueEFFICIENCY	OM 642.832	170	231	05/11->
Biofunctional cabin filter. right-hand drive.				
MERCEDES-BENZ C-Klasse (W204/C204/S204) C 320 CDI	OM 642.960	165	224	03/07->
Biofunctional cabin filter. right-hand drive.				
MERCEDES-BENZ C-Klasse (W204/C204/S204) C 350	M 272.961	200	272	03/07->





Application

		kW	HP	
Biofunctional cabin filter. right-hand drive.				
MERCEDES-BENZ C-Klasse (W204/C204/S204) C 350 CDI	OM 642.960	165	224	07/09->
Biofunctional cabin filter. right-hand drive.				
MERCEDES-BENZ C-Klasse (W204/C204/S204) C 350 CDI BlueEFFICIENCY	OM 642.830/832	170	231	11/09-04/11
Biofunctional cabin filter. right-hand drive.				
MERCEDES-BENZ C-Klasse (W204/C204/S204) C 350 CDI BlueEFFICIENCY	OM 642.834	195	265	05/11->
Biofunctional cabin filter. right-hand drive.				
MERCEDES-BENZ C-Klasse (W204/C204/S204) C 350 CGI BlueEFFICIENCY	M 272.982	215	292	11/08-02/11
Biofunctional cabin filter. right-hand drive.				
MERCEDES-BENZ C-Klasse (W204/C204/S204) C 350 CGI BlueEFFICIENCY	M 276.957	225	306	03/11->
Biofunctional cabin filter. right-hand drive.				
MERCEDES-BENZ C-Klasse (W204/C204/S204) C 63 AMG	M 156.985	336	457	09/07->
Biofunctional cabin filter. right-hand drive.				
MERCEDES-BENZ C-Klasse (W204/C204/S204) C 63 AMG Black Series	M 156.985	380	517	01/12->
Biofunctional cabin filter. right-hand drive.				
MERCEDES-BENZ C-Klasse (W204/C204/S204) C 63 AMG Edition 507	M 156.985	373	507	04/13->
Biofunctional cabin filter. right-hand drive.				
MERCEDES-BENZ C-Klasse (W204/C204/S204) C 63 AMG Performance P+	M 156.985	358	487	12/09->
Biofunctional cabin filter. right-hand drive.				
MERCEDES-BENZ CLS (C218) CLS Shooting Brake (X218) CLS 220 CDI BlueTEC	OM 651.924	125	170	09/14->
Biofunctional cabin filter. right-hand drive.				
MERCEDES-BENZ CLS (C218) CLS Shooting Brake (X218) CLS 250 CDI BlueTEC	OM 651.924	150	204	02/11->
Biofunctional cabin filter. right-hand drive.				
MERCEDES-BENZ CLS (C218) CLS Shooting Brake (X218) CLS 350	M 276.952	225	306	12/10->
Biofunctional cabin filter. right-hand drive.				
MERCEDES-BENZ CLS (C218) CLS Shooting Brake (X218) CLS 350 CDI BlueTEC	OM 642.853/854	195	265	12/10->
Biofunctional cabin filter. right-hand drive.				
MERCEDES-BENZ CLS (C218) CLS Shooting Brake (X218) CLS 350 CDI BlueTEC	OM 642.853	190	258	11/12->
Biofunctional cabin filter. right-hand drive.				
MERCEDES-BENZ CLS (C218) CLS Shooting Brake (X218) CLS 350 CDI BlueTEC	OM 642.852/858	185	252	11/12->
Biofunctional cabin filter. right-hand drive.				
MERCEDES-BENZ CLS (C218) CLS Shooting Brake (X218) CLS 400	M 276.820/850	245	333	09/14->



Application

		kW	HP	
Biofunctional cabin filter. right-hand drive.				
MERCEDES-BENZ CLS (C218) CLS Shooting Brake (X218) CLS 500	M 278.922	300	408	04/11->
Biofunctional cabin filter. right-hand drive.				
MERCEDES-BENZ CLS (C218) CLS Shooting Brake (X218) CLS 63 AMG	M 157.980/981	386	525	04/11->
Biofunctional cabin filter. right-hand drive.				
MERCEDES-BENZ CLS (C218) CLS Shooting Brake (X218) CLS 63 AMG	M 157.980/981 Performance+	410	557	04/11->
Biofunctional cabin filter. right-hand drive.				
MERCEDES-BENZ CLS (C218) CLS Shooting Brake (X218) CLS 63 AMG	M 157.980/981 Performance+	430	585	02/13->
Biofunctional cabin filter. right-hand drive.				
MERCEDES-BENZ E-Klasse (W/S212) E 180	M 274.910 (1.6)	115	156	03/13->
Biofunctional cabin filter. right-hand drive.				
MERCEDES-BENZ E-Klasse (W/S212) E 200	M 274.920	135	184	02/13->
Biofunctional cabin filter. right-hand drive.				
MERCEDES-BENZ E-Klasse (W/S212) E 200 CDI BE / BlueTEC	OM 651.925	100	136	09/09->
Biofunctional cabin filter. right-hand drive.				
MERCEDES-BENZ E-Klasse (W/S212) E 200 CGI BlueEFFICIENCY	M 271.820	135	184	09/09->
Biofunctional cabin filter. right-hand drive.				
MERCEDES-BENZ E-Klasse (W/S212) E 200 NGT	M 271.958	120	163	01/11->
Biofunctional cabin filter. right-hand drive.				
MERCEDES-BENZ E-Klasse (W/S212) E 200 NGT	M 274.920	115	156	08/13->
Biofunctional cabin filter. right-hand drive.				
MERCEDES-BENZ E-Klasse (W/S212) E 220 BlueTEC	OM 651.924	130	177	05/15->
Biofunctional cabin filter. right-hand drive.				
MERCEDES-BENZ E-Klasse (W/S212) E 220 CDI BE / BlueTEC	OM 651.924	125	170	03/09->
Biofunctional cabin filter. right-hand drive.				
MERCEDES-BENZ E-Klasse (W/S212) E 250	M 274.920	155	211	02/13->
Biofunctional cabin filter. right-hand drive.				
MERCEDES-BENZ E-Klasse (W/S212) E 250 CDI BlueEFFICIENCY	OM 651.924	150	204	03/09->
Biofunctional cabin filter. right-hand drive.				
MERCEDES-BENZ E-Klasse (W/S212) E 250 CGI BlueEFFICIENCY	M 271.860	150	204	09/09->
Biofunctional cabin filter. right-hand drive.				
MERCEDES-BENZ E-Klasse (W/S212) E 300	M 272.952	170	231	03/09->
Biofunctional cabin filter. right-hand drive.				
MERCEDES-BENZ E-Klasse (W/S212) E 300 BlueEFFICIENCY	M 276.952	185	252	07/11->
Biofunctional cabin filter. right-hand drive.				
MERCEDES-BENZ E-Klasse (W/S212) E 300 CDI BE / BlueTEC	OM 642.850/858	170	231	08/10->



Application

		kW	HP	
Biofunctional cabin filter. right-hand drive.				
MERCEDES-BENZ E-Klasse (W/S212) E 300 CDI BlueEFFICIENCY	OM 642.850	150	204	02/10-08/10
Biofunctional cabin filter. right-hand drive.				
MERCEDES-BENZ E-Klasse (W/S212) E 300 CDI BlueTEC Hybrid	OM 651.924	170	231	06/12->
Biofunctional cabin filter. right-hand drive.				
MERCEDES-BENZ E-Klasse (W/S212) E 350	M 272.977/980	200	272	03/09-08/11
Biofunctional cabin filter. right-hand drive.				
MERCEDES-BENZ E-Klasse (W/S212) E 350 BlueEFFICIENCY	M 276.952	225	306	06/11->
Biofunctional cabin filter. right-hand drive.				
MERCEDES-BENZ E-Klasse (W/S212) E 350 CDI BlueEFFICIENCY	OM 642.850	170	231	03/09-09/10
Biofunctional cabin filter. right-hand drive.				
MERCEDES-BENZ E-Klasse (W/S212) E 350 CDI BlueEFFICIENCY	OM 642.852/858	195	265	08/10->
Biofunctional cabin filter. right-hand drive.				
MERCEDES-BENZ E-Klasse (W/S212) E 350 CDI BlueTEC	OM 642.850	155	211	09/09->
Biofunctional cabin filter. right-hand drive.				
MERCEDES-BENZ E-Klasse (W/S212) E 350 CDI BlueTEC	OM 642.858	185	252	03/13->
Biofunctional cabin filter. right-hand drive.				
MERCEDES-BENZ E-Klasse (W/S212) E 350 CDI BlueTEC	OM 642.852/858	190	258	05/14->
Biofunctional cabin filter. right-hand drive.				
MERCEDES-BENZ E-Klasse (W/S212) E 350 CGI BlueEFFICIENCY	M 272.983	215	292	03/09-09/11
Biofunctional cabin filter. right-hand drive.				
MERCEDES-BENZ E-Klasse (W/S212) E 400	M 276.820/850	245	333	02/13->
Biofunctional cabin filter. right-hand drive.				
MERCEDES-BENZ E-Klasse (W/S212) E 500	M 273.971	285	387	03/09-09/11
Biofunctional cabin filter. right-hand drive.				
MERCEDES-BENZ E-Klasse (W/S212) E 500 BlueEFFICIENCY	M 278.922	300	408	09/11->
Biofunctional cabin filter. right-hand drive.				
MERCEDES-BENZ E-Klasse (W/S212) E 63 AMG	M 156.985	386	525	08/09-04/11
Biofunctional cabin filter. right-hand drive.				
MERCEDES-BENZ E-Klasse (W/S212) E 63 AMG	M 157.980/981	386	525	05/11->
Biofunctional cabin filter. right-hand drive.				
MERCEDES-BENZ E-Klasse (W/S212) E 63 AMG	M 157.980/981	410	557	05/11->
Biofunctional cabin filter. right-hand drive.				
MERCEDES-BENZ E-Klasse (W/S212) E 63 AMG S	M 157.980/981	430	585	04/13->
Biofunctional cabin filter. right-hand drive.				
MERCEDES-BENZ E-Klasse Coupé / Cabriolet (A/C207) E 200	M 274.920	135	184	04/13->
Biofunctional cabin filter. right-hand drive.				





Application

		kW	HP	
MERCEDES-BENZ E-Klasse Coupé / Cabriolet (A/C207) E 200 CGI BlueEFFICIENCY	M 271.820	135	184	02/10->
Biofunctional cabin filter. right-hand drive.				
MERCEDES-BENZ E-Klasse Coupé / Cabriolet (A/C207) E 220 CDI BE/BlueTEC	OM 651.911	125	170	02/10->
Biofunctional cabin filter. right-hand drive.				
MERCEDES-BENZ E-Klasse Coupé / Cabriolet (A/C207) E 250	M 274.920	155	211	04/13->
Biofunctional cabin filter. right-hand drive.				
MERCEDES-BENZ E-Klasse Coupé / Cabriolet (A/C207) E 250 CDI BE/BlueTEC	OM 651.911	150	204	09/09->
Biofunctional cabin filter. right-hand drive.				
MERCEDES-BENZ E-Klasse Coupé / Cabriolet (A/C207) E 250 CGI BlueEFFICIENCY	M 271.860	150	204	09/09->
Biofunctional cabin filter. right-hand drive.				
MERCEDES-BENZ E-Klasse Coupé / Cabriolet (A/C207) E 300 CGI BlueEFFICIENCY	M 276.957	185	252	05/11->
Biofunctional cabin filter. right-hand drive.				
MERCEDES-BENZ E-Klasse Coupé / Cabriolet (A/C207) E 320	M 276.820	200	272	07/14->
Biofunctional cabin filter. right-hand drive.				
MERCEDES-BENZ E-Klasse Coupé / Cabriolet (A/C207) E 350 CDI BlueEFFICIENCY	OM 642.836	170	231	05/09->
Biofunctional cabin filter. right-hand drive.				
MERCEDES-BENZ E-Klasse Coupé / Cabriolet (A/C207) E 350 CDI BlueEFFICIENCY	OM 642.852/858	195	265	05/11->
Biofunctional cabin filter. right-hand drive.				
MERCEDES-BENZ E-Klasse Coupé / Cabriolet (A/C207) E 350 CDI BlueTEC	OM 642.838	185	252	04/13->
Biofunctional cabin filter. right-hand drive.				
MERCEDES-BENZ E-Klasse Coupé / Cabriolet (A/C207) E 350 CDI BlueTEC	OM 642.838	190	258	05/14->
Biofunctional cabin filter. right-hand drive.				
MERCEDES-BENZ E-Klasse Coupé / Cabriolet (A/C207) E 350 CGI BlueEFFICIENCY	M 272.983	215	292	05/09->
Biofunctional cabin filter. right-hand drive.				
MERCEDES-BENZ E-Klasse Coupé / Cabriolet (A/C207) E 350 CGI BlueEFFICIENCY	M 276.957	225	306	01/11->
Biofunctional cabin filter. right-hand drive.				
MERCEDES-BENZ E-Klasse Coupé / Cabriolet (A/C207) E 400	M 276.820/850	245	333	04/13->
Biofunctional cabin filter. right-hand drive.				
MERCEDES-BENZ E-Klasse Coupé / Cabriolet (A/C207) E 500	M 273.971	285	387	05/09-09/11
Biofunctional cabin filter. right-hand drive.				
MERCEDES-BENZ E-Klasse Coupé / Cabriolet (A/C207) E 500 BlueEFFICIENCY	M 278.922	300	408	09/11->
Biofunctional cabin filter. right-hand drive.				
MERCEDES-BENZ GLK (X204) GLK 200	M274.920	135	184	09/13->



Application



		kW	HP	
Biofunctional cabin filter. right-hand drive.				
MERCEDES-BENZ GLK (X204) GLK 200 CDI BE	OM 651.913	105	143	07/10->
Biofunctional cabin filter. right-hand drive.				
MERCEDES-BENZ GLK (X204) GLK 220 CDI BE/BlueTEC	OM 651.916, OM 651.912	125	170	04/09->
Biofunctional cabin filter. right-hand drive.				
MERCEDES-BENZ GLK (X204) GLK 250	M274.920	155	211	05/13->
Biofunctional cabin filter. right-hand drive.				
MERCEDES-BENZ GLK (X204) GLK 250 CDI BE	OM 651.912	150	204	12/09->
Biofunctional cabin filter. right-hand drive.				
MERCEDES-BENZ GLK (X204) GLK 280	M 272.948	170	231	10/08-06/09
Biofunctional cabin filter. right-hand drive.				
MERCEDES-BENZ GLK (X204) GLK 300	M 272.948	170	231	06/09-04/11
Biofunctional cabin filter. right-hand drive.				
MERCEDES-BENZ GLK (X204) GLK 320 CDI	OM 642.961	165	224	06/08-06/09
Biofunctional cabin filter. right-hand drive.				
MERCEDES-BENZ GLK (X204) GLK 350	M 272.961	200	272	10/08-04/11
Biofunctional cabin filter. right-hand drive.				
MERCEDES-BENZ GLK (X204) GLK 350 CDI	OM 642.961	165	224	06/09-12/10
Biofunctional cabin filter. right-hand drive.				
MERCEDES-BENZ GLK (X204) GLK 350 CDI	OM 642.832	170	231	10/10-07/12
Biofunctional cabin filter. right-hand drive.				
MERCEDES-BENZ GLK (X204) GLK 350 CDI BlueEFFICIENCY	OM 642.835	195	265	05/12->
Biofunctional cabin filter. right-hand drive.				
MERCEDES-BENZ GLK (X204) GLK 350 CGI BlueEFFICIENCY	M 276.957	225	306	01/11->
Biofunctional cabin filter. right-hand drive.				
MERCEDES-BENZ SL (R231) SL 350	M276.954	225	306	02/12-05/14
Biofunctional cabin filter. right-hand drive.				
MERCEDES-BENZ SL (R231) SL 400	M276.825	245	333	04/14->
Biofunctional cabin filter. right-hand drive.				
MERCEDES-BENZ SL (R231) SL 400	M276.825	270	367	03/16->
Biofunctional cabin filter. right-hand drive.				
MERCEDES-BENZ SL (R231) SL 500	M278.927	320	435	02/12->
Biofunctional cabin filter. right-hand drive.				
MERCEDES-BENZ SL (R231) SL 500	M278.927	335	455	04/15->
Biofunctional cabin filter. right-hand drive.				
MERCEDES-BENZ SL (R231) SL 63 AMG	M157.983	395	537	04/12->
Biofunctional cabin filter. right-hand drive.				
MERCEDES-BENZ SL (R231) SL 63 AMG	M157.983	430	585	04/14->
Biofunctional cabin filter. right-hand drive.				
MERCEDES-BENZ SL (R231) SL 63 AMG PP	M157.983 Performance+	415	564	04/12->

FP 29 005/1

12/2015



Application

		kW	HP	
Biofunctional cabin filter. right-hand drive.				
MERCEDES-BENZ SL (R231) SL 65 AMG	M279.981	463	630	09/12->
Biofunctional cabin filter. right-hand drive.				
MERCEDES-BENZ SLS AMG (C197) 6.2 AMG	M159.980	420	571	03/10->
Biofunctional cabin filter. right-hand drive.				
MERCEDES-BENZ SLS AMG (C197) 6.2 AMG Black Series	M159.980	464	631	03/13->
Biofunctional cabin filter. right-hand drive.				
MERCEDES-BENZ SLS AMG (C197) 6.2 AMG GT	M159.980	435	591	10/12->
Biofunctional cabin filter. right-hand drive.				

FP 1828

12/2015



no image available

Filter type	Cabin Filter
GTIN code	4011558065690
Delivery status	available
Product Details	FreciousPlus. Biofunctional cabin filter

Cross reference

SUBARU
72880-AG000
72880-XA00A
72880-AG0009P
G3010-AG100
TOYOTA
88568-52010-83
08974-00820
87139-52010
88568-52010

Application



		kW	HP	
CARS + TRANSPORTERS				
SUBARU Legacy III 2.0 Diesel		110	150	02/08->
Biofunctional cabin filter.				
SUBARU Outback II 2.0 Diesel		110	150	02/08-09/09
Biofunctional cabin filter.				
TOYOTA RAV 4 II 1.8 VVTi	1ZZ-FE	92	125	06/00-02/06
Biofunctional cabin filter.				
TOYOTA RAV 4 II 2.0 D-4D Turbodiesel	1CD-FTV	84	114	07/01-02/06
Biofunctional cabin filter.				
TOYOTA RAV 4 II 2.0 VVTi	1AZ-FE	110	150	06/00-02/06
Biofunctional cabin filter.				
TOYOTA Yaris I / Yaris Verso (P1) 1.0 16V	1SZ-FE	48	65	03/03-09/05
Country of vehicle manufacture Japan. Biofunctional cabin filter.				
TOYOTA Yaris I / Yaris Verso (P1) 1.0 16V	1SZ-FE	50	68	04/99-09/05
Country of vehicle manufacture Japan. Biofunctional cabin filter.				
TOYOTA Yaris I / Yaris Verso (P1) 1.3	2SZ-FE	64	87	04/02-09/05
Country of vehicle manufacture Japan. Biofunctional cabin filter.				
TOYOTA Yaris I / Yaris Verso (P1) 1.3	2NZ-FE	63	86	11/99-05/02
Country of vehicle manufacture Japan. Biofunctional cabin filter.				
TOYOTA Yaris I / Yaris Verso (P1) 1.4 D-4D	1ND-TV	55	75	09/01-09/05
Country of vehicle manufacture Japan. Biofunctional cabin filter.				

FP 1828

12/2015



Application

		kW	HP	
TOYOTA Yaris I / Yaris Verso (P1) 1.5 TS	1NZ-FE	78	106	02/01-09/05
Country of vehicle manufacture Japan. Biofunctional cabin filter.				
TOYOTA Yaris I / Yaris Verso (P1) 1.5 VVT-i	1NZ-FE	110	150	03/03-07/05
Country of vehicle manufacture Japan. Biofunctional cabin filter.				

FP 2335 KIT

12/2015



no image available

Filter type	Cabin Filter
GTIN code	4011558067557
Delivery status	available
Product Details	FreciousPlus. Biofunctional cabin filter

Cross reference

FIAT GROUP (ALFA/FIAT/LANCIA)	UAZ
46770834	151.1109080
77362394	151.1109080-10
46722863	
46770829	
46723245	
46723331	
46722862	

Application



	CARS + TRANSPORTERS			
FIAT Doblò / Doblò Cargo (119/223) 1.2	223A5.000	48	65	11/00->
Biofunctional cabin filter.				
FIAT Doblò / Doblò Cargo (119/223) 1.3 JTD		51	70	04/04-12/05
Biofunctional cabin filter.				
FIAT Doblò / Doblò Cargo (119/223) 1.3 Multijet 16V JTD		62	85	11/05->
Biofunctional cabin filter.				
FIAT Doblò / Doblò Cargo (119/223) 1.3 Multijet 16V JTD		55	75	11/05->
Biofunctional cabin filter.				
FIAT Doblò / Doblò Cargo (119/223) 1.4 8V		57	77	10/05->
Biofunctional cabin filter.				
FIAT Doblò / Doblò Cargo (119/223) 1.6 16V	182.A4.000	76	103	01/01->
Biofunctional cabin filter.				
FIAT Doblò / Doblò Cargo (119/223) 1.9 D		46	63	11/00->
Biofunctional cabin filter.				
FIAT Doblò / Doblò Cargo (119/223) 1.9 JTD	182.B4.000	74	100	01/01->
Biofunctional cabin filter.				
FIAT Doblò / Doblò Cargo (119/223) 1.9 JTD 105		77	105	07/03->
Biofunctional cabin filter.				
FIAT Doblò / Doblò Cargo (119/223) 1.9 JTD 120		88	120	11/05->
Biofunctional cabin filter.				
FIAT Idea (135/235) 1.2 16V		59	80	01/04->
Biofunctional cabin filter.				

FP 2335 KIT

12/2015



Application



		kW	HP	
FIAT Idea (135/235) 1.3 JTD 70		51	70	01/04->
Biofunctional cabin filter.				
FIAT Idea (135/235) 1.3 JTD 90		66	90	10/05->
Biofunctional cabin filter.				
FIAT Idea (135/235) 1.4 16V		70	95	01/04->
Biofunctional cabin filter.				
FIAT Idea (135/235) 1.4 8V		57	77	10/05->
Biofunctional cabin filter.				
FIAT Idea (135/235) 1.4 LPG		57	77	03/09->
Biofunctional cabin filter.				
FIAT Idea (135/235) 1.6 Multijet MJTD		88	120	06/08->
Biofunctional cabin filter.				
FIAT Idea (135/235) 1.9 JTD		74	100	01/04->
Biofunctional cabin filter.				
FIAT Punto II (188/188AX) 1.2 16V	176B9.000	59	80	09/99->
Biofunctional cabin filter.				
FIAT Punto II (188/188AX) 1.2 8V	188A4.000	44	60	09/99-10/09
Biofunctional cabin filter.				
FIAT Punto II (188/188AX) 1.2 Natural Power	188 A4.000	44	60	09/03->
Biofunctional cabin filter.				
FIAT Punto II (188/188AX) 1.3 JTD	188 A9.000	51	70	07/03-10/05
Biofunctional cabin filter.				
FIAT Punto II (188/188AX) 1.4 16V	843 A1.000	70	95	07/03->
Biofunctional cabin filter.				
FIAT Punto II (188/188AX) 1.8 16V	183A1.000	96	130	09/99->
Biofunctional cabin filter.				
FIAT Punto II (188/188AX) 1.9 D	188A3.000	44	60	09/99-09/03
Biofunctional cabin filter.				
FIAT Punto II (188/188AX) 1.9 JTD	188A7.000	63	85	11/01-10/09
Biofunctional cabin filter.				
FIAT Punto II (188/188AX) 1.9 JTD	188 B2.000	74	100	07/03->
Biofunctional cabin filter.				
FIAT Punto II (188/188AX) 1.9 JTD	188A2.000	59	80	09/99-09/03
Biofunctional cabin filter.				
LANCIA (LANCIA AUTOBIANCHI) Musa 1.3 JTD		51	70	09/04-12/09
Biofunctional cabin filter.				
LANCIA (LANCIA AUTOBIANCHI) Musa 1.3 JTD		66	90	09/04-12/09
Biofunctional cabin filter.				
LANCIA (LANCIA AUTOBIANCHI) Musa 1.3 MJTD		70	95	01/10->
Biofunctional cabin filter.				

FP 2335 KIT

12/2015



Application

		kW	HP	
LANCIA (LANCIA AUTOBIANCHI) Musa 1.4 16V		70	95	09/04->
Biofunctional cabin filter.				
LANCIA (LANCIA AUTOBIANCHI) Musa 1.4 16V		66	90	09/04->
Biofunctional cabin filter.				
LANCIA (LANCIA AUTOBIANCHI) Musa 1.4 8V		57	77	04/06->
Biofunctional cabin filter.				
LANCIA (LANCIA AUTOBIANCHI) Musa 1.4 LPG		57	77	11/10->
Biofunctional cabin filter.				
LANCIA (LANCIA AUTOBIANCHI) Musa 1.6 MJTD		88	120	06/08-12/09
Biofunctional cabin filter.				
LANCIA (LANCIA AUTOBIANCHI) Musa 1.9 JTD		74	100	09/04-05/08
Biofunctional cabin filter.				
LANCIA (LANCIA AUTOBIANCHI) Ypsilon (843) 1.2	188 A4.000	44	60	10/03-12/11
Biofunctional cabin filter.				
LANCIA (LANCIA AUTOBIANCHI) Ypsilon (843) 1.2 16V		59	80	10/03-09/06
Biofunctional cabin filter.				
LANCIA (LANCIA AUTOBIANCHI) Ypsilon (843) 1.3 JTD		51	70	10/03-09/06
Biofunctional cabin filter.				
LANCIA (LANCIA AUTOBIANCHI) Ypsilon (843) 1.3 JTD		55	75	10/06-12/11
Biofunctional cabin filter.				
LANCIA (LANCIA AUTOBIANCHI) Ypsilon (843) 1.3 JTD		66	90	10/06-12/11
Biofunctional cabin filter.				
LANCIA (LANCIA AUTOBIANCHI) Ypsilon (843) 1.3 JTD		77	105	05/07-12/11
Biofunctional cabin filter.				
LANCIA (LANCIA AUTOBIANCHI) Ypsilon (843) 1.4		57	77	10/06-12/11
Biofunctional cabin filter.				
LANCIA (LANCIA AUTOBIANCHI) Ypsilon (843) 1.4 16V		70	95	10/03-12/11
Biofunctional cabin filter.				
UAZ Hunter 2.7	ZMZ-409.10	94	128	07/04->
Biofunctional cabin filter.				
UAZ Patriot 2.7	ZMZ-409.10	94	128	07/04->
Biofunctional cabin filter.				

HU 6015 z KIT

12/2015



no image available

Filter type	Oil Filter
GTIN code	4011558067403
Delivery status	available

Cross reference

BMW
11 42 8 570 590
11 42 8 575 210

Competitor no.

FRAM
CH11885ECO
MAHLE (KNECHT/MAHLE)
OX 815
OX 815D

MECAFILTER
ELH 4464
PURFLUX
L1045

Application



		kW	HP	
CARS + TRANSPORTERS				
BMW 2 Active / Gran Tourer (F45, F46) 214d	B37	70	95	03/15->
BMW 2 Active / Gran Tourer (F45, F46) 216d	B37	85	116	11/14->
BMW 2 Active / Gran Tourer (F45, F46) 216i	B38A15A	75	102	07/15->
BMW 2 Active / Gran Tourer (F45, F46) 218d	B47	110	150	08/14->
BMW 2 Active / Gran Tourer (F45, F46) 218i	B38	100	136	08/14->
BMW 2 Active / Gran Tourer (F45, F46) 220d	B47C20A	140	190	11/14->
BMW 2 Active / Gran Tourer (F45, F46) 220i	B48	141	192	11/14->
BMW 2 Active / Gran Tourer (F45, F46) 225i	B48	170	231	08/14->
BMW 2 Active / Gran Tourer (F45, F46) 225xe	B38A15A	165	224	11/15->
BMW X1 (F48) 16d	B37C15A	85	116	06/15->
BMW X1 (F48) 18d	B47C20A	110	150	06/15->
BMW X1 (F48) 18i	B38A15A	100	136	06/15->
BMW X1 (F48) 20d	B47C20A	140	190	06/15->
BMW X1 (F48) 20i	B48A20A	141	192	06/15->
BMW X1 (F48) 25d	B47C20B	170	231	06/15->
BMW X1 (F48) 25i	B48A20B	170	231	06/15->
BMW X1 (F48) 28i	B48A20B	170	231	06/15->
BMW i8 (I12) i8	B38K15 (170 kW)	266	362	04/14->
MINI (BMW GROUP) Mini III (F54, F55, F56, F57) 1.2 (One First)	B38A12A	55	75	07/14->
MINI (BMW GROUP) Mini III (F54, F55, F56, F57) 1.2 (One)	B38A12	75	102	02/14->

HU 6015 z KIT

12/2015



Application

		kW	HP	
MINI (BMW GROUP) Mini III (F54, F55, F56, F57) 1.5 (Cooper)	B38A15	100	136	02/14->
MINI (BMW GROUP) Mini III (F54, F55, F56, F57) 1.5 (One)	B38A15A	75	102	07/15->
MINI (BMW GROUP) Mini III (F54, F55, F56, F57) 1.5 Diesel (Cooper D)	B37C15	85	116	02/14->
MINI (BMW GROUP) Mini III (F54, F55, F56, F57) 1.5 Diesel (One D)	B37C15	70	95	02/14->
MINI (BMW GROUP) Mini III (F54, F55, F56, F57) 1.5 Diesel (One D)	B37C15A	85	116	07/15->
MINI (BMW GROUP) Mini III (F54, F55, F56, F57) 2.0 (Cooper D)	B47C20A	110	150	07/15->
MINI (BMW GROUP) Mini III (F54, F55, F56, F57) 2.0 (Cooper S)	B46A20A, B48A20A	141	192	02/14->
MINI (BMW GROUP) Mini III (F54, F55, F56, F57) 2.0 Diesel (Cooper SD)	B47C20A	125	170	07/14->
MINI (BMW GROUP) Mini III (F54, F55, F56, F57) 2.0 Diesel (Cooper SD)	B47C20A	140	190	07/15->
MINI (BMW GROUP) Mini III (F54, F55, F56, F57) 2.0 JCW	B48A20B	170	231	03/15->

HU 7033 z

12/2015



no image available

Filter type	Oil Filter
GTIN code	4011558067465
Delivery status	available

Cross reference



CITROEN
16 106 937 80
PEUGEOT
16 106 937 80

Competitor no.

MAHLE (KNECHT/MAHLE)
OX 171/2
OX 171/2 D1

MECAFILTER
ELH 4461

Application

			kW	HP	
CARS + TRANSPORTERS					
CITROEN Berlingo II (B9) 1.6 BlueHDi 100	DV6FD		73	99	02/15->
CITROEN Berlingo II (B9) 1.6 BlueHDi 120	DV6FD		88	120	02/15->
CITROEN C-Elysée 1.6 HDi 100	BHY (DV6FD)		73	99	11/14->
CITROEN C3 II (A51) 1.6 BlueHDi 100	DV6FD		73	99	11/14->
CITROEN C3 II (A51) 1.6 BlueHDi 75	BHW (DV6FE)		55	75	04/15->
CITROEN C3 Picasso 1.6 BlueHDi 100	DV6FD		73	99	01/15->
CITROEN C4 Cactus 1.6 BlueHDi 100	DV6FD		73	99	05/14->
CITROEN C4 II (B7) 1.6 BlueHDi 100	DV6FD		73	99	11/14->
CITROEN C4 II (B7) 1.6 BlueHDi 115	BHX (DV6FC)		85	116	08/14->
CITROEN C4 II (B7) 1.6 BlueHDi 120	DV6FC		88	120	11/14->
CITROEN C4 Picasso II (B78) / Grand C4 Picasso II (B78) 1.6 BlueHDi 100	DV6FD		73	99	01/15->
CITROEN C4 Picasso II (B78) / Grand C4 Picasso II (B78) 1.6 BlueHDi 120	DV6FC		88	120	07/14->
CITROEN DS3 1.6 BlueHDi 100	DV6FD		73	99	06/14->
CITROEN DS3 1.6 BlueHDi 115	DV6FC		85	116	03/14->
CITROEN DS3 1.6 BlueHDi 120	DV6FC		88	120	03/14->
CITROEN DS3 1.6 BlueHDi 75	BHW (DV6FE)		55	75	03/15->
CITROEN DS4 1.6 BlueHDi 115	DV6FC		85	116	11/14->
CITROEN DS4 1.6 BlueHDi 120	DV6FC		88	120	11/14->
CITROEN DS5 1.6 BlueHDi 115	DV6FC		85	116	12/13->
CITROEN DS5 1.6 BlueHDi 120	DV6FC		88	120	01/14->



HU 7033 z

12/2015

Available
now!

**MANN
FILTER**

Application

		kW	HP	
PEUGEOT 2008 1.6 BlueHDi 100	DV6FD	73	99	12/14->
PEUGEOT 2008 1.6 BlueHDi 115	DV6FC	85	116	12/14->
PEUGEOT 2008 1.6 BlueHDi 120	DV6FC	88	120	12/14->
PEUGEOT 2008 1.6 BlueHDi 75	BHW (DV6FE)	55	75	01/15->
PEUGEOT 208 1.6 BlueHDi 100	DV6FD	73	100	01/15->
PEUGEOT 208 1.6 BlueHDi 115	BHX (DV6FC)	85	116	01/15->
PEUGEOT 208 1.6 BlueHDi 120	DV6FC	88	120	01/15->
PEUGEOT 3008 1.6 BlueHDi 120	DV6FC	88	120	07/14->
PEUGEOT 301 1.6 BlueHDi 100	DV6FD	73	99	04/14->
PEUGEOT 308 II 1.6 BlueHDi 100	DV6FD	73	99	03/14->
PEUGEOT 308 II 1.6 BlueHDi 120	DV6FC	88	120	03/14->
PEUGEOT 308 II 1.6 BlueHDi 95	DV6FD	70	95	03/14->
PEUGEOT 5008 1.6 BlueHDi 120	DV6FC	88	120	07/14->
PEUGEOT 508 1.6 BlueHDi 115	BHX (DV6FC)	85	116	03/14->
PEUGEOT 508 1.6 BlueHDi 120	BHZ (DV6FC)	88	120	03/14->
PEUGEOT Partner II 1.6 BlueHDi 100	DV6FD	73	99	02/15->
PEUGEOT Partner II 1.6 BlueHDi 120	DV6FC	88	120	02/15->
PEUGEOT Partner II 1.6 HDi, 1.6 BlueHDi 75	DV6BTED4, DV6ETED4, DV6FE (E6)	55	75	04/08->

Engine code DV6FE (Euro 6).

PL 601

12/2015



Filter type	Fuel Filter
GTIN code	4011558034184
Delivery status	available

Dimensions (mm)

A	B	C	G	H
108	103	112	1-14 UNS - 1B	268



Representative image

W 936/10

12/2015

Available
now!

**MANN
FILTER**

Filter type	Oil Filter
GTIN code	4011558067977
Delivery status	available
Wrench removal tool	LS 9

Dimensions (mm)

A	B	C	G	H
93	62	71	3/4-16 UNF-1B	142



Representative image





Cross reference

BOGE
558 001 000P

Competitor no.

HIFI-FILTER
SH 62236

Application



		kW	HP	
 OFF-HIGHWAY APPLICATIONS				
 Compressors				
BOGE SO - Serie 100A		75	102	
->10/04. use for OE no. 558001000P.				
BOGE SO - Serie 100W		75	102	
->10/04. use for OE no. 558001000P.				
BOGE SO - Serie 125A		90	122	
->10/04. use for OE no. 558001000P.				
BOGE SO - Serie 125W		90	122	
->10/04. use for OE no. 558001000P.				
BOGE SO - Serie 151A		110	150	
->10/04. use for OE no. 558001000P.				
BOGE SO - Serie 151W		110	150	
->10/04. use for OE no. 558001000P.				
BOGE SO - Serie 181A		132	179	
->10/04. use for OE no. 558001000P.				

W 936/10

12/2015



Application

	kW	HP	
BOGE SO - Serie 181W ->10/04. use for OE no. 558001000P.	132	179	
BOGE SO - Serie 200A ->10/04. use for OE no. 558001000P.	145	197	
BOGE SO - Serie 200W ->10/04. use for OE no. 558001000P.	145	197	

WD 10 004

12/2015



Filter type	Hydraulics
GTIN code	4011558063269
Delivery status	available
Predecessor	W 935/1

Dimensions (mm)

A	B	C	H
96	60	73	148



Representative image



Cross reference

AGCO	
3621294M1	
ARGO (ODG)	
3621294M1	
BOBCAT	
6653336	
CASE CONSTRUCTION	
H-311654	
CATERPILLAR	
085-0261	
4T-6915	
CLARK MICHIGAN	
6653336	
HITACHI	
4363399	
ISEKI	
156051527200	
J.C.BAMFORD	
KNJ0288A	
KNJ0288	
JOHN DEERE	
AT79590	
MASSEY-FERGUSON	
3621294M1	
MELROE-BOBCAT	
6653336	
TAKEUCHI	
155103-5118	
T1551000320	
VOLVO (TRUCKS/VCE/VME/PENTA)	
14524170	
3177754	
20801559	

Competitor no.

BALDWIN	
BT8898	
BT260-10	
DONALDSON	
P766756	
P556005	
FLEETGUARD/CUMMINS FILTRATION	
HF6204	
HF7551	
HF7955	
HF35556	
HENGST	
H17W22	
HIFI-FILTER	
SH 60204	
SCHUPP / SF FILTER	
SPH 9608	
SPH 9711	

Application



		kW	HP	
	TRUCKS + BUSES			
OPTARE Olympus Olympus	Volvo D9B260	191	260	11/06->
for hydrostatic fan.				
OPTARE Olympus Olympus	Volvo D9B310	228	310	11/06->
for hydrostatic fan.				
VOLVO BUS 7000 7500	D9A-340	250	340	03/06->
for hydrostatic fan.				
VOLVO BUS 7000 7700	D9B260 Euro 4/5	191	260	09/06->

WD 10 004

12/2015



Application



		kW	HP	
for hydrostatic fan.				
VOLVO BUS 7000 7700 CNG	G9A260 (E4/5/EEV)	191	260	09/06->
for hydrostatic fan.				
VOLVO BUS 7000 7700 CNG	G9A300 (E4/5/EEV)	223	303	09/06->
for hydrostatic fan.				
VOLVO BUS 7000 7700 Hybrid	D5E E5/EEV	154	210	10/09->
for hydrostatic fan.				
VOLVO BUS 7000 7700, 7700 A	D9B310 Euro 4/5	228	310	09/06->
for hydrostatic fan.				
VOLVO BUS 7000 7700, 7700 A	D9B360 Euro 4/5	265	360	09/06->
for hydrostatic fan.				
VOLVO BUS 8000 8500	DH12D	250	340	01/99->
for hydrostatic fan.				
VOLVO BUS 8000 8500	DH12E340 Euro 4/5	250	340	06/06->
for hydrostatic fan.				
VOLVO BUS 8000 8700	DH12D-380	279	380	09/01->
for hydrostatic fan.				
VOLVO BUS 8000 8700	DH12D-340	250	340	09/03->
for hydrostatic fan.				
VOLVO BUS 8000 8700	DH12D-420	309	420	09/04->
for hydrostatic fan.				
VOLVO BUS 8000 8700	D7C-275	202	275	09/04->
for hydrostatic fan.				
VOLVO BUS 8000 8700	D7C-310	228	310	09/04->
for hydrostatic fan.				
VOLVO BUS 8000 8700	D7E-290 Euro 4/5	213	290	09/06->
for hydrostatic fan.				
VOLVO BUS 8000 8700	DH12E340 Euro 4/5	250	340	06/06->
for hydrostatic fan.				
VOLVO BUS 8000 8700	DH12E380 Euro 4/5	280	380	06/06->
for hydrostatic fan.				
VOLVO BUS 8000 8700	D7E-340 Euro 4/5	250	340	09/06->
for hydrostatic fan.				
VOLVO BUS 8000 8900	D7E-290 E5	213	290	10/10->
for hydrostatic fan.				
VOLVO BUS 8000 8900	D9B-380 E5	279	380	10/10->
for hydrostatic fan.				
VOLVO BUS 8000 8900	D8K E6	257	350	02/14->
for hydrostatic fan.				
VOLVO BUS 8000 8900	D8K E6	235	320	02/14->

WD 10 004

12/2015



Application



		kW	HP	
for hydrostatic fan.				
VOLVO BUS 8000 8900	D8K E6	206	280	02/14->
for hydrostatic fan.				
VOLVO BUS 9000 9500	D9A/B/C-380	279	380	02/11->
for hydrostatic fan.				
VOLVO BUS 9000 9500	D8K E6	235	320	02/14->
for hydrostatic fan.				
VOLVO BUS 9000 9500	D8K E6	257	350	02/14->
for hydrostatic fan.				
VOLVO BUS 9000 9700	DH12D380	280	380	09/01-09/06
for hydrostatic fan.				
VOLVO BUS 9000 9700	DH12D420	308	420	09/01-09/06
for hydrostatic fan.				
VOLVO BUS 9000 9700	DH12D340	250	341	09/01-09/06
for hydrostatic fan.				
VOLVO BUS 9000 9700	DH12E340 Euro 4/5	250	340	09/06->
for hydrostatic fan.				
VOLVO BUS 9000 9700	DH12E380 Euro 4/5	279	380	09/06->
for hydrostatic fan.				
VOLVO BUS 9000 9700	DH12E420 Euro 4/5	309	420	09/06->
for hydrostatic fan.				
VOLVO BUS 9000 9700	DH12E460 Euro 4/5	338	460	09/06->
for hydrostatic fan.				
VOLVO BUS 9000 9700	DH13C420 E5	309	420	10/09->
for hydrostatic fan.				
VOLVO BUS 9000 9700	DH13C460 E5	338	460	10/09->
for hydrostatic fan.				
VOLVO BUS 9000 9700	D11K E6	316	430	02/14->
for hydrostatic fan.				
VOLVO BUS 9000 9700	D11K E6	338	460	02/14->
for hydrostatic fan.				
VOLVO BUS 9000 9700	D11K E6	279	380	02/14->
for hydrostatic fan.				
VOLVO BUS 9000 9900	DH12D420	308	420	09/01-09/06
for hydrostatic fan.				
VOLVO BUS 9000 9900	DH12D380	280	380	09/01-09/06
for hydrostatic fan.				
VOLVO BUS 9000 9900	DH12E380 Euro 4/5	279	380	09/06->
for hydrostatic fan.				
VOLVO BUS 9000 9900	DH12E340 Euro 4/5	250	340	09/06->

WD 10 004

12/2015



Application

		kW	HP	
for hydrostatic fan.				
VOLVO BUS 9000 9900	DH12E420 Euro 4/5	309	420	09/06->
for hydrostatic fan.				
VOLVO BUS 9000 9900	DH12E460 Euro 4/5	338	460	09/06->
for hydrostatic fan.				
VOLVO BUS 9000 9900	DH13C420 E5	309	420	10/09->
for hydrostatic fan.				
VOLVO BUS 9000 9900	DH13C460 E5	338	460	10/09->
for hydrostatic fan.				
VOLVO BUS 9000 9900	D11K E6	339	461	07/13->
for hydrostatic fan.				
VOLVO BUS 9000 9900	D11K E6	316	430	07/13->
for hydrostatic fan.				
VOLVO BUS B11R B11R	D11K E6	279	380	09/13->
for hydrostatic fan.				
VOLVO BUS B11R B11R	D11K E6	339	460	09/13->
for hydrostatic fan.				
VOLVO BUS B11R B11R	D11K E6	316	430	09/13->
for hydrostatic fan.				
VOLVO BUS B13 B13R	DH13C460 E5	338	460	09/09->
for hydrostatic fan.				
VOLVO BUS B7 B7R, B7RLE	D7C-275	202	275	09/03->
for hydrostatic fan.				
VOLVO BUS B7 B7R, B7RLE	D7C-310	228	310	09/03->
for hydrostatic fan.				
VOLVO BUS B7 B7R, B7RLE	D7E-290 Euro 4/5	213	290	09/06->
for hydrostatic fan.				
VOLVO BUS B7 B7R, B7RLE	D7E-340 Euro 4/5	250	340	09/06->
for hydrostatic fan.				
VOLVO BUS B8 B8R, B8RLE	D8K E6	257	350	09/13->
for hydrostatic fan.				
VOLVO BUS B8 B8R, B8RLE	D8K E6	235	320	09/13->
for hydrostatic fan.				
VOLVO BUS B8 B8R, B8RLE	D8K E6	206	280	09/13->
for hydrostatic fan.				
VOLVO BUS B9 B9L/TL	D9B-260	191	260	09/06->
for hydrostatic fan.				
VOLVO BUS B9 B9L/TL	D9B-310	228	310	09/06->
for hydrostatic fan.				
VOLVO BUS B9 B9R Elegance	D9A-340	250	340	10/06->

WD 10 004

12/2015





Application

		kW	HP	
for hydrostatic fan.				
VOLVO BUS B9 B9R Elegance	D9A-380	279	380	10/06->
for hydrostatic fan.				
VOLVO BUS B9 B9TL	D9A-340	250	340	03/02-08/06
for hydrostatic fan.				
VOLVO BUS B9 B9TL	D9A-310	228	310	03/02-08/06
for hydrostatic fan.				
OFF-HIGHWAY APPLICATIONS				
Construction and mining				
BOBCAT 200-Serie 220				
BOBCAT 200-Serie 220				
BOBCAT 200-Serie 225				
BOBCAT 200-Serie 225				
BOBCAT 200-Serie 231				
BOBCAT 200-Serie 231				
BOBCAT 300-Serie 316				
BOBCAT 300-Serie 319				
BOBCAT 300-Serie 320				
BOBCAT 300-Serie 320				
BOBCAT 300-Serie 320D				
BOBCAT 300-Serie 321				
BOBCAT 300-Serie 322				
BOBCAT 300-Serie 322 D & G Series				
BOBCAT 300-Serie 323				
BOBCAT 300-Serie 324				
BOBCAT 300-Serie 325				
BOBCAT 300-Serie 325				
BOBCAT 300-Serie 325				
BOBCAT 300-Serie 328				
BOBCAT 300-Serie 331				
BOBCAT 300-Serie 331				
BOBCAT 300-Serie 334				
BOBCAT 400-Serie 418				
BOBCAT E-Serie (Minibagger / Mini Excavators) E08	Kubota D722			
BOBCAT E-Serie (Minibagger / Mini Excavators) E10	Kubota D722			
BOBCAT E-Serie (Minibagger / Mini Excavators) E14	Kubota D722			
BOBCAT E-Serie (Minibagger / Mini Excavators) E16	Kubota D722			
BOBCAT MT-Serie (Deltalader / Compact Track Loaders) MT50				





Application

		kW	HP	
BOBCAT X-Serie (Minibagger / Mini Excavators) X 220				
BOBCAT X-Serie (Minibagger / Mini Excavators) X 320	Kubota D750			
BOBCAT X-Serie (Minibagger / Mini Excavators) X 320 / 322	Kubota D722			
BOBCAT X-Serie (Minibagger / Mini Excavators) X 325	Kubota D1703B	20,5	27	
BOBCAT X-Serie (Minibagger / Mini Excavators) X 325 / X 328		20	27	
BOBCAT X-Serie (Minibagger / Mini Excavators) X 331 / X 334	Kubota V2203E	30	40	
CATERPILLAR 600 (Schürfzüge / Scrapers) 623 E	Cat 3406			
CATERPILLAR 600 (Schürfzüge / Scrapers) 623 F	Cat 3406			
CATERPILLAR 600 (Schürfzüge / Scrapers) 623 G use for OE no. 4T-6915.				
CATERPILLAR 700-Series (Muldenkipper / Dumper / Mining Trucks) 789 B	Cat 3516			
CATERPILLAR 700-Series (Muldenkipper / Dumper / Mining Trucks) 789 C	Cat 3516 TA-EUI	1335	1820	
CATERPILLAR 700-Series (Muldenkipper / Dumper / Mining Trucks) 793 B	Cat 3516			
CATERPILLAR 700-Series (Muldenkipper / Dumper / Mining Trucks) 793 C	Cat 3516B-EUI	1615	2202	
CATERPILLAR 900 (Radlader / Wheel Loaders) 988 F	Cat 3408			
CATERPILLAR 900 (Radlader / Wheel Loaders) 988 F Serie II	Cat 3408 E			
CATERPILLAR D5 (Planiertrauben / Bulldozers) D5 H	Cat 3304			
CATERPILLAR D5 (Planiertrauben / Bulldozers) D5 H LGP Serie II	Cat 3304			
CATERPILLAR D5 (Planiertrauben / Bulldozers) D5 H TSK	Cat 3304			
CATERPILLAR D5 (Planiertrauben / Bulldozers) D5 H XL	Cat 3304			
CATERPILLAR D6 (Planiertrauben / Bulldozers) D6 M	Cat 3116			
CATERPILLAR D6 (Planiertrauben / Bulldozers) D6 M LGP	Cat 3116 T	104	142	
CATERPILLAR D6 (Planiertrauben / Bulldozers) D6 M XL	Cat 3116 T	104	142	
CATERPILLAR D8 (Planiertrauben / Bulldozers) D8 L	Cat 3408			
JCB (J.C. BAMFORD) JS / JZ (Hydraulikbagger / Hydraulic Excavators) JS 160	Isuzu 4JJ1-SJ01			
JCB (J.C. BAMFORD) JS / JZ (Hydraulikbagger / Hydraulic Excavators) JS 160	Isuzu 4BG1 TPA 03 Low Emission	81	110	
JCB (J.C. BAMFORD) JS / JZ (Hydraulikbagger / Hydraulic Excavators) JS 160	Isuzu 4BG1 TRA05 Tier 2	81	110	
JCB (J.C. BAMFORD) JS / JZ (Hydraulikbagger / Hydraulic Excavators) JS 160 AUTO	Isuzu 4BG1-TRA05 Low Emission			
JCB (J.C. BAMFORD) JS / JZ (Hydraulikbagger / Hydraulic Excavators) JS 160 LC, LC TAB, NLC, NLC TA		72	98	1997-1999
JCB (J.C. BAMFORD) JS / JZ (Hydraulikbagger / Hydraulic Excavators) JS 160 W	Isuzu 4JJ1-SJ01	92	125	2008-2013



Application



		kW	HP	
JCB (J.C. BAMFORD) JS / JZ (Hydraulikbagger / Hydraulic Excavators) JS 160 W	Isuzu 4BG1 TPA 03 Low Emission	92	125	
JCB (J.C. BAMFORD) JS / JZ (Hydraulikbagger / Hydraulic Excavators) JS 160 W PLE	Perkins 1004-4T AK Tier 1			
JCB (J.C. BAMFORD) JS / JZ (Hydraulikbagger / Hydraulic Excavators) JS 160 W, W TAB				
JCB (J.C. BAMFORD) JS / JZ (Hydraulikbagger / Hydraulic Excavators) JS 160 W-T2	Isuzu 4BG1-TRA05 Low Emission			
JCB (J.C. BAMFORD) JS / JZ (Hydraulikbagger / Hydraulic Excavators) JS 220 LC, LR, S T2	Dieselmax			
JCB (J.C. BAMFORD) JS / JZ (Hydraulikbagger / Hydraulic Excavators) JS 220 LC, SC CH	Dieselmax			
JCB (J.C. BAMFORD) JS / JZ (Hydraulikbagger / Hydraulic Excavators) JS 220, HD, L.Reach, XD	Isuzu 6BG1 TRB05 Tier 2	102	139	
JCB (J.C. BAMFORD) JS / JZ (Hydraulikbagger / Hydraulic Excavators) JS 220, LR, XD	Isuzu 4HK1 SJ-02 Tier 3	128	174	2008-2013
JCB (J.C. BAMFORD) JS / JZ (Hydraulikbagger / Hydraulic Excavators) JS200 W Isuzu				
JCB (J.C. BAMFORD) JS / JZ (Hydraulikbagger / Hydraulic Excavators) JS210 T2				
JCB (J.C. BAMFORD) JS / JZ (Hydraulikbagger / Hydraulic Excavators) JS240				
JCB (J.C. BAMFORD) JS / JZ (Hydraulikbagger / Hydraulic Excavators) JS240 Tier 4				
JCB (J.C. BAMFORD) JS / JZ (Hydraulikbagger / Hydraulic Excavators) JZ 140	Isuzu 4BG1-TRA04 Tier 2 Low Em	72	98	
JCB (J.C. BAMFORD) JS / JZ (Hydraulikbagger / Hydraulic Excavators) JZ 140	Isuzu 4JJ1-SJ01 Tier 3 S	72	98	2008-2013
JCB (J.C. BAMFORD) JS / JZ (Hydraulikbagger / Hydraulic Excavators) JZ 140 HD	Isuzu 4JJ1-SJ01 Tier 3S	72	98	2009-2013
JCB (J.C. BAMFORD) JS / JZ (Hydraulikbagger / Hydraulic Excavators) JZ 140 R	Isuzu 4JJ1-SJ01 Tier 3S	72	98	2009->
JCB (J.C. BAMFORD) JS / JZ (Hydraulikbagger / Hydraulic Excavators) JZ 140 WM	Isuzu 4JJ1-SJ01 Tier 3S	72	98	2009->
TAKEUCHI TB - Kompaktbagger orange / Compact Excavators TB 15	Yanmar 3TNA72L-UTB			
TAKEUCHI TB 0 (Kompaktbagger / Compact Excavators) TB 007	Yanmar 2TN66L-UTBA; 2TNE68-ETB			
TAKEUCHI TB 0 (Kompaktbagger / Compact Excavators) TB 015	Yanmar 3TNA72L-UTBZ			
TAKEUCHI TB 1 (Kompaktbagger / Compact Excavators) TB 108	Yanmar 2TNV70 / 2TNE68-ETBA	7	10	
TAKEUCHI TC / TCR (Raupendumper / Crawler Dumpers) TCR 50	Yanmar 4 TNE 106 TB			
	from chassis no. 30500039.			
TAKEUCHI TC / TCR (Raupendumper / Crawler Dumpers) TCR 50	4TNN106-NTB, -NTB1			

WD 10 004

12/2015



Application

		kW	HP	
TAKEUCHI TC / TCR (Raupendumper / Crawler Dumpers) TCR 50	4JJ1XYBB-01			
VOLVO CONSTRUCTION EQUIPMENT EC / ECR (Kettenbagger / Crawler Excavators) EC 180 B LC	D6D EHE2			
 Agricultural machinery				
ISEKI SF-Serie 300 / 330 / 303 / 333				
ISEKI TH 4000-Serie 4290 / 4330				
ISEKI TK-Serie 532 / 538				

WK 9055 z

12/2015

Available
now!

**MANN
FILTER**

Filter type	Fuel Filter
GTIN code	4011558068127
Delivery status	available

Dimensions (mm)

A	G	H
93	1-14 UNS-2B	103



Cross reference

CHRYSLER USA
4723905
FIAT GROUP (ALFA/FIAT/LANCIA)
K4723905

Competitor no.

Competitor Brand	Competitor Part Number
BLUEPRINT	ADA 102305
BOSCH	1 457 434 448
CHAMPION	CFF100501
	L 501/606
	L 501
	L 143/606
	L 143
COOPERS	FSM 4162
COOPERSFIAAM	FT5457
	FT5632
FRAM	P9486
HENGST	H7020WK10
MAHLE (KNECHT/MAHLE)	KC 238 D
MECAFILTER	ELG 5220
PURFLUX	CS467
PUROLATOR	F 57834
RACOR (PARKER-RACOR)	R20T
TECNOCAR	RN138
UFI	24.331.00

Application



	kW	HP	⌚
 CARS + TRANSPORTERS			
CHRYSLER Voyager / Grand Voyager (ES) 2.5 TD	87	118	04/92-03/95

WK 9055 z

12/2015



Application

		kW	HP	
JEEP Cherokee I (XJ) 2.5 TD		85	116	01/88-11/01
JEEP Cherokee I (XJ) 2.5 TD	M51, M52	89	121	10/95-11/01
JEEP Grand Cherokee I (Z/ZJ) 2.5 TD	M51	85	115	10/95-04/99